

Data Sheet



Article number: 3901030015100

Description: Worm gear with solid input shaft
VF 30N-15-HS

Measures

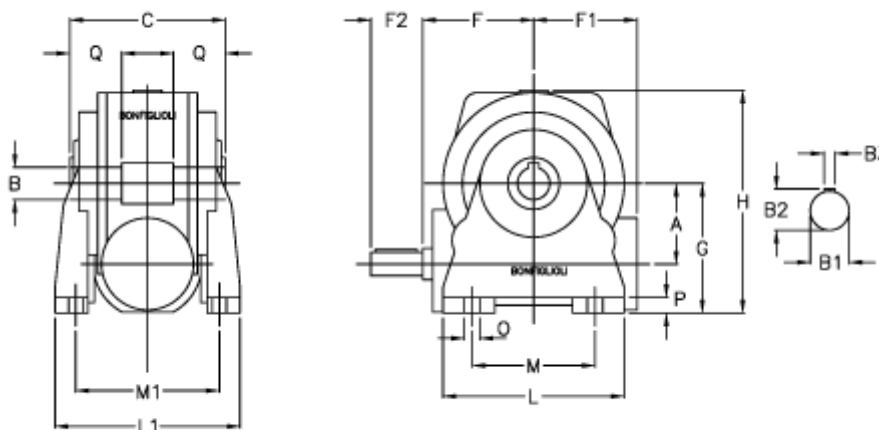

a	= 30.0	F1 = 46	O = 6.5
B	= 14	F2 = 20	P = 8
B1	= 9	g = 55	Q = 20.5
B2	= 10.2	H = 96.0	
B3	= 3	L = 80	
C	= 55	L1 = 80	
Description = VF 30N-xx-HS		m = 50	
F	= 50.0	M1 = 66.0	